



Product Manual

F3A1

mycubii.com

 @mycubii

 Cubii

 mycubii

FCC ID: 2AF6U-F3728A
Fitness Cubed Inc
Last Modified: 4/5/17

Table of Contents

| | |
|--|----|
| Before You Begin | |
| Safety Instructions | 2 |
| Equipment Warning, Caution & Notice Labels | 2 |
| Getting Started | |
| What's Included | 5 |
| Assembling Cubii | 6 |
| Connecting with Mobile Device | 7 |
| Setting up Cubii on an iOS Device | 7 |
| Exercising with your Cubii | |
| Tips for Use | 12 |
| Finding your comfort zone | 12 |
| Using the Chair Wheel Stopper | 12 |
| Adjusting the Resistance | 12 |
| Battery Life and Power | 14 |
| Carrying Cubii | 14 |
| Storage | 15 |
| Care and Maintenance | 15 |
| General Info and Specifications | |
| Sensors and Motors | 16 |
| Size and Weight | 16 |
| Environmental Conditions | 16 |
| Help | 16 |
| Return Policy and Warranty | 16 |
| Regulatory and Safety Notices | |
| USA: FCC Statement | 17 |
| FCC Warning | 17 |
| EU | 17 |
| Important Safety Instructions | 18 |
| Built-in Battery Precautions | 18 |
| Disposal and Recycling Information | 19 |

NOTE: Please be advised that the content of this Product Manual may change periodically to reflect the most recent hardware and software updates. You may be notified about major changes via your Cubii app and email.

Last Modified: April 15th, 2017

Before You Begin

Welcome to the Cubii community. Whether you are a busy professional or a stay-home parent, you've taken a big stride towards a life more active, productive and fulfilling.

Before you begin, we want you to be familiar with important information on how to use Cubii safely so that you and your loved ones do not get hurt. Let's review the safety notes and warnings now.

If you have any questions, please contact support@mycubii.com.

Safety Instructions

WARNING Consult your physician before starting this or any exercise program. This is especially important if you are over the age of 35, have never exercised before, are pregnant, or suffer from any health problem.

WARNING Do not use when standing. Only use when sitting. Failure to follow all warnings and instructions could result in serious injury or death.

WARNING To reduce the risk of serious injury, read the following Safety Instructions before using Cubii.

1. Read all warnings and cautions posted on Cubii.
2. Cubii should only be used after a thorough review of the Product Manual.
3. We recommend that two people be available for assembly of this product.
4. Keep children away from Cubii. Do not allow children to use or play on Cubii. Keep children and pets away from Cubii when it is in use.
5. Set up and operate Cubii on a solid level surface. Do not position Cubii on loose rugs or uneven surfaces.
6. Make sure that adequate space is available for access to and around Cubii.
7. Before using, inspect Cubii for worn or loose components, and securely tighten or replace any worn or loose components prior to use.
8. Consult a physician prior to commencing an exercise program. If, at any time during exercise, you feel faint, dizzy, or experience pain, stop and consult your physician.
9. Follow your physician's recommendations in developing your own personal fitness program.
10. Always choose the workout which best fits your physical strength and flexibility level. Know your limits and train within them. Always use common sense when exercising.
11. Do not wear loose or dangling clothing while using Cubii.

F3A1 Cubii Smart Under-Desk Elliptical

12. Never exercise in bare feet or socks; always wear correct footwear, such as running, walking, or crosstraining shoes. Be sure that they fit well, provide foot support and feature non-skid rubber soles.
13. Be careful to maintain your balance on your chair while using, mounting, dismounting, or assembling Cubii; loss of balance may result in a fall and serious bodily injury.
14. Keep both feet firmly and securely on the pedal caps while exercising.
15. Cubii should not be used by persons weighing over 250 pounds.
16. Cubii should be used by only one person at a time.



**USE ONLY WHILE SITTING.
DO NOT STAND ON THE UNIT.**

Equipment Warning, Caution & Notice Labels

This chart is provided to help identify the warning, caution, and notice labels on Cubii. Please take a moment to familiarize yourself with all of the warning, caution, and notice labels

(1) Main Warning

Label is larger than actual size

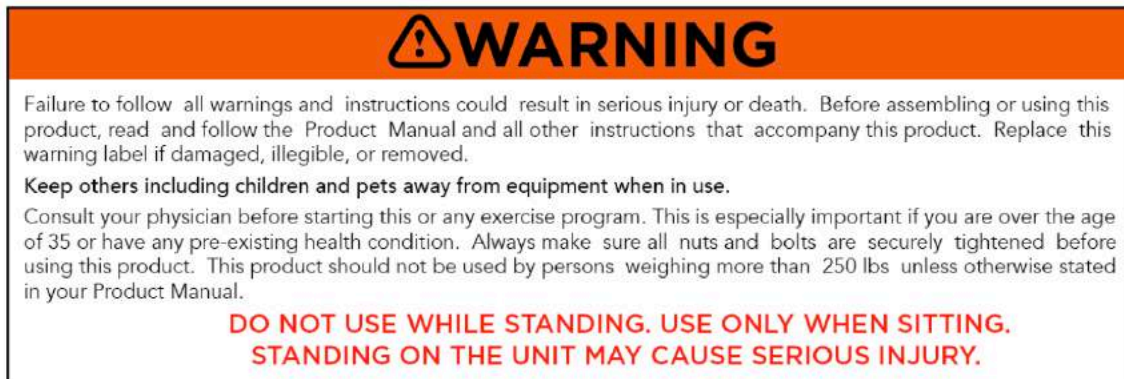

(2) Pre-use Warning

Label is smaller than actual size



Getting Started

What's Included

Your Cubii box includes:

- (1) Cubii Smart Elliptical (x1)
- (2) Right Pedal (x1)
- (3) Left Pedal (x1)
- (4) Micro USB Cable (x1)
- (5) Power Adapter 100-240V AC (x1)
- (6) Screwdriver (x1)
- (7) Screws (x4)
- (8) Chair Wheel Stopper (x2)



Cubii Smart Elliptical (x1)

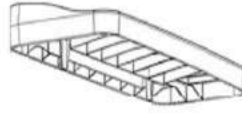

Pedal (x2)



Screw (x4)



Screwdriver (x1)



Micro USB Cable (x1)

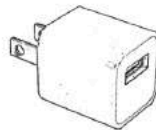

Power Adapter (x1)

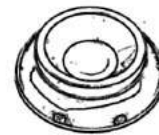

Chair Wheel Stopper (x2)

If any of the components listed above are missing in your box, or broken, please reach out to support@mycubii.com, and indicate which component needs replacement along with photos of breakage, if applicable.

Assembling Cubii

Here's an instruction on how to assemble Cubii after you unbox. Refer to the section "What's Included" for a complete list of components. It is also recommended that you assemble Cubii with a friend, family member or colleague to help secure the pedals in place while you screw them in.

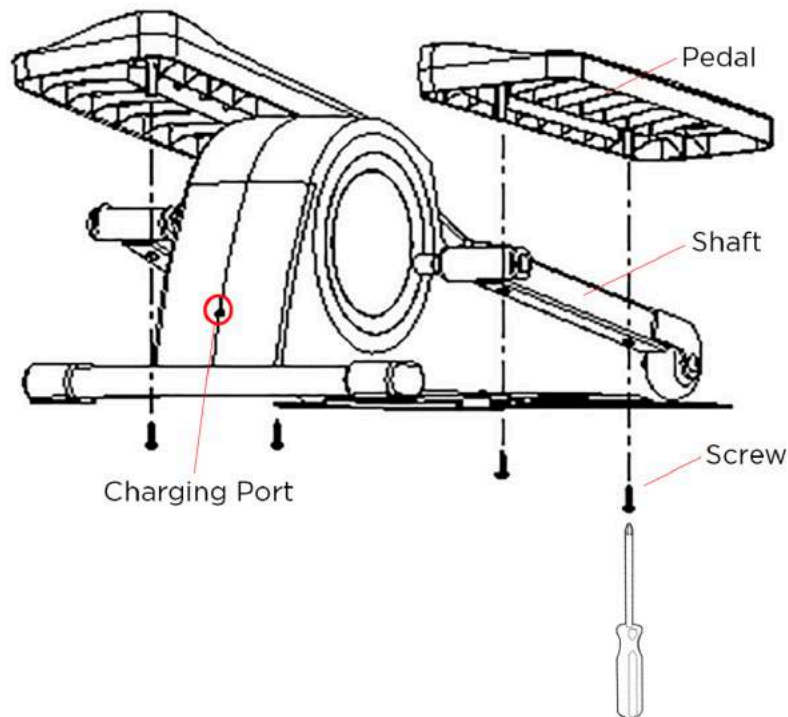

1. Place the right pedal on top of the right shaft so that the screw holes are aligned. Refer to the diagram above
2. Keeping the pedal in position, flip it over by the hinge so the pedal is underneath the shaft and the screw holes are exposed on top.
3. Screw the pedal in by using the screwdriver. Make sure that the pedal is secured tightly to avoid noise, risk of damage, and injury.
4. Repeat steps 1-3 for the left pedal.

In case you have trouble assembling, here is a video to help you get started: mycubii.com/tutorial

Connecting with Mobile Device

Compatible devices

Cubii can be set up and synced with select mobile devices that support Bluetooth 4.0 technology. Currently, we support iPhone 5 and above running iOS 8 or higher, and Android devices running Android OS 4.4 or higher. Please note that tablets including iPads and certain Android phone models are not supported.

Setting Up Cubii on your Mobile Device

Before you begin

Your Cubii must be charged before you can pair it with your mobile device.

1. Plug the smaller end of the Micro USB Cable into the charging port located at the rear end of your Cubii. Plug into a wall outlet using the Power Adapter to start charging.
2. The Battery LED light will blink as Cubii is charging. When the Battery LED light turns green, your Cubii will be fully charged. Charging Cubii completely can take up to 6 hours.
3. You can start setting up your mobile app once Cubii begins charging.

Installing the Cubii app

You can visit mycubii.com/app to download the Cubii app from the App Store for iOS or the Google Play Store for Android. If you already have the Cubii app installed, check for available updates to make sure you have the latest version.

Pairing Cubii with your mobile phone for the first time

Cubii is a Bluetooth Low Energy (BLE) device, as opposed to a Classic Bluetooth accessory, like headsets. It must be paired directly through the Cubii app, and not through the Settings app on your phone. Before you begin, make sure you have enabled Bluetooth under Settings on your phone.

1. Open the Cubii app. Before creating an account, be sure to read the [Terms of Use](#) and [Privacy Policy](#). The links are located at the bottom of the signup screen.
2. Create an account:
 - a. Select **SIGN UP** if you don't already have a Cubii account.

Note: Click **LOGIN** if you're an existing Cubii app user. One app can be paired with multiple Cubii devices.

You may also click **LOGIN WITH FACEBOOK** if you want to log in using your Facebook account. To share your exercise update with your friends on Facebook, you need to sign up for the Cubii app via your Facebook account.

- b. Enter the email address and password you'd like to use for your Cubii account.
 - Check "Stay up to date!" to receive competition announcements and monthly stats.
 - Check "Add me to Public groups" to join the Cubii Global group and compete with other customers.

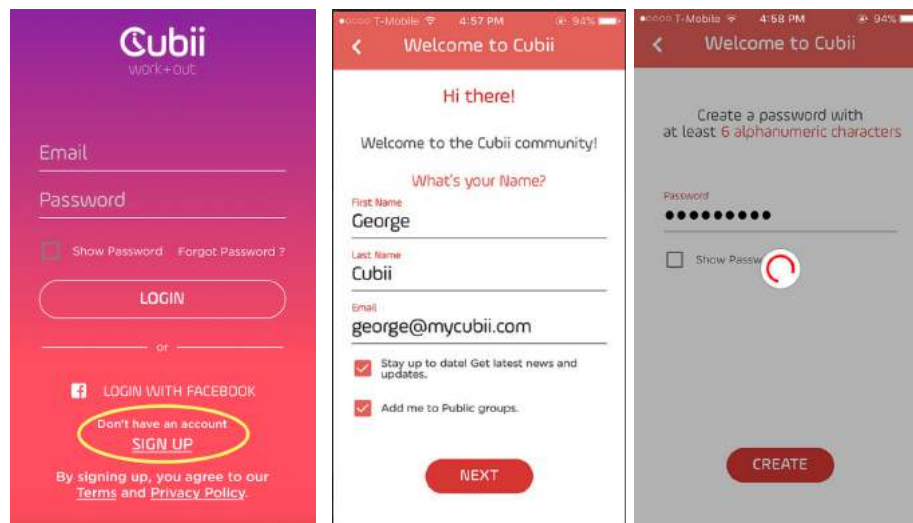

- c. Once you have logged into your account, enter your personal details. This information personalizes your Cubii experience and improves the accuracy of your calorie burn and distance data. Your name is, by default, public and visible in Group user search. You can adjust your privacy settings under **Settings** in the Cubii app.

F3A1 Cubii Smart Under-Desk Elliptical

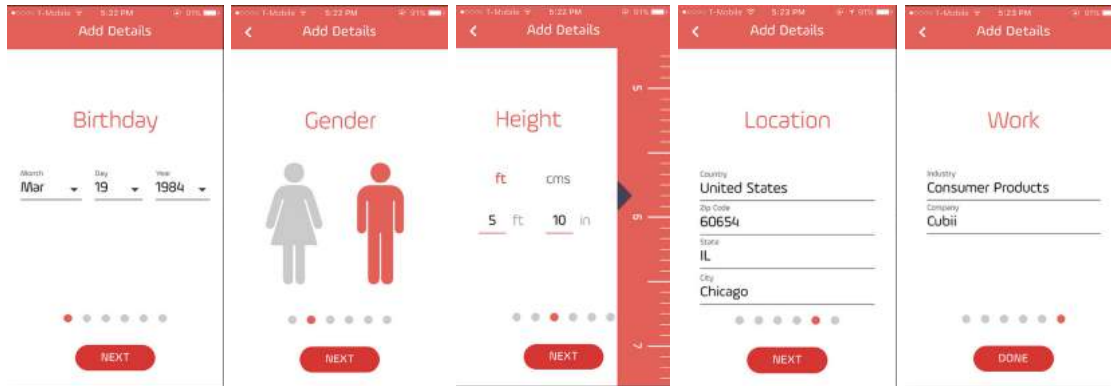

3. To turn on Cubii, start pedaling for 5 seconds. You'll see the Bluetooth LED light glow and start blinking in blue.
4. On the app screen, you will see your Cubii pop up under **Cubii Devices Found**. Tap on the Cubii device you're setting up.



5. Once successfully paired, the Bluetooth LED light on your Cubii will stop blinking and remain illuminated in blue.
6. Now you can name your Cubii, and tap **Done** to finish setup, and see your dashboard.
7. From here on, every time you launch the app, it will search for all Cubii devices in your vicinity and automatically pair up with a Cubii you have previously paired.
8. In order to pair with a new Cubii in the same vicinity, you must first disconnect from the previous Cubii. Go to the Pick your Cubii page by clicking on the Bluetooth Pair/Unpair button (battery icon) on the Dashboard. Tap on the Cubii you'd like to disconnect from. Click on **Disconnect**.

Note: If you experience trouble pairing your Cubii, you can get support by emailing the Cubii support team at support@mycubii.com

Pairing Cubii automatically with your phone for subsequent connections

Your Cubii can connect directly to supported devices via Bluetooth. Connection between Cubii and mobile phone occurs automatically every time you open the Cubii app, as long as Bluetooth is enabled in the iOS or Android device Settings.

Note: The Cubii app should remain open in the background in order for Cubii to send data to your phone. If the app is closed, no data gets received and recorded by your mobile phone.

Real-time Dashboard

You can use the Cubii app to see your stats update in real time. Open the Cubii app. Once your Cubii connects with your device, the message “Connected to your Cubii” will appear on the Bluetooth Pair/Unpair button (battery icon). Start pedaling to see your stats update instantly.

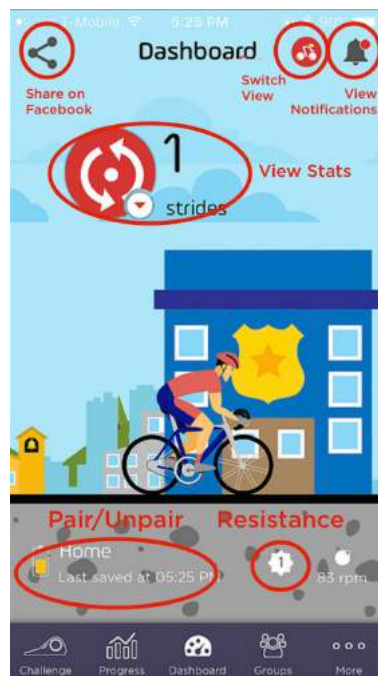

Deep Sleep Mode

After 4 minutes of inactivity, your Cubii enters Deep Sleep Mode to conserve battery life. Under Deep Sleep Mode, the Bluetooth on Cubii turns off, and no data gets received by the mobile phone. Your mobile phone will not be able to connect automatically with Cubii when it enters Deep Sleep Mode. To turn Cubii Bluetooth on, start pedaling.

Offline Mode

Your Cubii will record your exercise data even when Bluetooth on your mobile phone is off or your phone is not in the vicinity of your Cubii. Your app will record all exercise data accumulated by Cubii the next time it establishes connection.

Detailed App Manual Available

For a more in-depth manual of the mobile application, please refer to the document titled "[Cubii Mobile App Manual](#)". Please note that this manual may be updated periodically to reflect the most recent version of the application.

Exercising with your Cubii

Tips for Use

- Cubii was designed for use only while sitting. Do not stand on the pedals. Cubii was not designed for use while standing. Standing on Cubii may result in serious injury.
- Before using Cubii, ensure that both pedals are on tight. Loose pedals will slowly come undone, create noise, and cause risk of damage and injury.
- Do not place Cubii in a location where it may cause an obstruction.
- If you find your knees hitting the desk, you may:
 - a. Lower your chair. This lowers your knees by several inches.
 - b. Move Cubii farther away from you to extend your legs more. Extending your legs lowers your knees.
- Sit up straight while using Cubii. This will help strengthen your core and is good for your spine.
- Keep your upper body still. Try not to rock from side to side and make sure you are pedaling with your legs and not your body.
- If are using a chair with wheels and find your chair moving when using Cubii, please refer to the below section, “Using the Chair Wheel Stopper.”

Consult your physician before starting this or any exercise program. This is especially important if you are over the age of 35 or have any pre-existing health condition. If you feel faint or dizzy, immediately discontinue use of this equipment. Serious bodily injury can occur if this equipment is not assembled and used correctly. Serious bodily injury can also occur if all instructions are not followed. Keep others and pets away from equipment when in use. Follow all safety instructions in this manual.

Finding your comfort zone

Adjust the distance between Cubii and your chair for the most comfortable position. If your knees hit the desk, try sitting away from Cubii or pushing Cubii further back if space allows. If your feet do not reach the pedals at your current chair configuration, try lowering your chair, and place Cubii closer to your feet.

Using the Chair Wheel Stopper

If you're using Cubii while sitting on a chair with wheels or castors, your chair may move. If this is happening, follow the steps below:

1. Place the provided wheel stopper under the front-most wheel on your chair. If you are using a four-legged chair with wheels, place a wheel stopper under each of the front wheels.
2. You can now resume using Cubii as you normally would.



1) 5-Wheel Chairs



2 stoppers

2) 5-Wheel Chairs



1 stopper

3) 4-Wheel Chairs



2 stoppers

Adjusting the Resistance

1. Cubii comes with 8 levels of resistance.
2. Turn the knob clockwise to increase the resistance. The higher the number, the higher the resistance. We highly recommend you begin at Level 1 and increase the intensity as you get used to the product.
3. To have the Cubii app record the most accurate calories burned, tap on the corresponding resistance level on the top bar of the Cubii app dashboard.

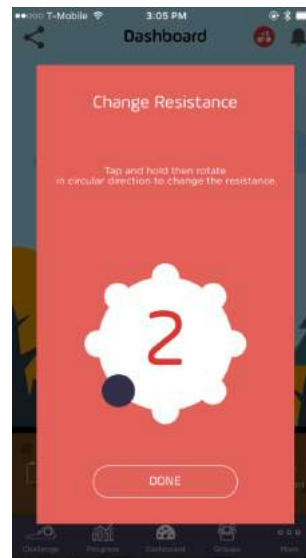

Battery Life and Power

Your Cubii comes equipped with a rechargeable lithium-polymer battery. With normal use, your Cubii should last about 90 days before you need to charge again. Charging Cubii completely can take up to 6 hours. You can check the battery level at the top right corner of your Cubii app dashboard or refer to the battery level LED light on Cubii.

The Battery LED will glow in the following colors:

Green: 70-100% charged

Yellow: 20-70% charged

Red: 0-20% charged

LED blinks when charging

To charge your Cubii, plug the charging cable into the charging port at the rear end of Cubii and charge using the provided adapter. The LED indicator light will glow orange as Cubii charges. When the LED light turns green, your Cubii will be fully charged. Charging completely can take up to 6 hours.

You can track your Cubii battery life on the app dashboard.

Carrying Cubii

To move Cubii around, carry it by the handle located at the top. For additional support, place your other hand under the base. Ask a friend, family member or colleague for help if you find it heavy. Do not use the pedal arms to move Cubii.



Storage

1. To store Cubii, simply keep it in a clean dry place.
2. Cubii is approximately 24 inches long x 12.5 inches wide x 12.5 inches tall.
3. Hold the handle to move Cubii. Do not use the pedal arms to move Cubii.

Care and Maintenance

The safety and integrity designed into Cubii can only be maintained when Cubii is regularly examined for damage and wear. Special attention should be given to the following:

1. Tighten the pedal screws regularly to ensure that the pedals are secured properly.
2. Adjust the Resistance Knob and verify that the flywheel provides tension. The flywheel should provide many years of use.
3. Verify that the Warning Label is in place and easy to read. Email Fitness Cubed Inc immediately at support@mycubii.com for a replacement Warning Label if it is missing or damaged.
4. It is the sole responsibility of the user/owner to ensure that regular maintenance is performed.
5. Worn or damaged components shall be replaced immediately or Cubii removed from service until repair is made. Email Fitness Cubed Inc at support@mycubii.com to request replacement parts.
6. Only Fitness Cubed Inc supplied components shall be used to maintain/repair Cubii.
7. Keep your Cubii clean by wiping it off with an absorbent cloth after use.

If you have any questions, please contact support@mycubii.com.

General Info and Specifications

Sensors and Motors

Your Cubii uses an RPM sensor that measures number of revolutions to help you determine calories burned, distance travelled, and number of strides.

Size and Weight

Length: 58.8 cm / 23.15 in
Width: 44.6 cm / 17.56 in
Height: 24.8 cm / 9.77 in
Weight: 12.50 kg / 27.56 lbs

Environmental Conditions

Operating Temperature: 24.0°C
Non-Operating Temperature: 32.0°C

Help

For troubleshooting and assistance for your Cubii, you can email us at support@mycubii.com.

Return Policy and Warranty

Warranty information and Cubii Return Policy can be found online at <http://mycubii.com/support>

Regulatory and Safety Notices

USA: Federal Communications Commission (FCC) Statement

This device complies with FCC part 15 FCC Rules. Operation is subject to the following two conditions:

1. This device may not cause harmful interference and
2. This device must accept any interference, including interference that may cause undesired operation of the device.

FCC Warning

Changes or modifications not expressly approved by the party responsible for compliance could void the user's authority to operate the equipment.

Note: This equipment has been tested and found to comply with the limits for a Class B digital device, pursuant to part 15 of the FCC Rules. These limits are designed to provide reasonable protection against harmful interference in a residential installation. This equipment generates, uses and can radiate radio frequency energy and, if not installed and used in accordance with the instructions, may cause harmful interference to radio communications. However, there is no guarantee that interference will not occur in a particular installation. If this equipment does cause harmful interference to radio or television reception, which can be determined by turning the equipment off and on, the user is encouraged to try to correct the interference by one or more of the following measures:

- Reorient or relocate the receiving antenna.
- Increase the separation between the equipment and receiver.
- Connect the equipment into an outlet on a circuit different from that to which the receiver is connected.
- Consult the dealer or an experienced radio/TV technician for help. This device meets the FCC and IC requirements for RF exposure in public or uncontrolled environments.

FCC ID: 2AF6U-F3728A

EU (European Union)

Declaration of Conformity with Regard to the EU Directive 1999/5/EC

Fitness Cubed Inc is authorized to apply the CE Mark on Cubii, Model F3A1, thereby declaring conformity to the essential requirements and other relevant provisions of Directive 1999/5/EC.

Compliant with the standard R&TTE 99/CE/05

Conforme à la norme R&TTE 99/CE/05

Important Safety Instructions

- Read and follow these instructions
- Cubii has been designed to be used only while sitting. Do not stand on the pedals as it was not designed to be used while standing.
- Make sure the pedals on Cubii are tight before use. Loose pedals will slowly come undone, create noise, and cause risk of damage and injury.
- Do not subject Cubii to heavy shock or treat it excessively. Do not attempt to disassemble or modify it.
- Use Cubii indoors on a level surface. Keep it away from moisture and dust.
- Do not expose Cubii to extremely high or low temperatures. Do not leave Cubii in direct sunlight for an extended period of time.
- Do not place Cubii in a location where it may cause an obstruction.
- Do not use abrasive cleaners to clean Cubii.
- Do not use any lubricants. They can damage the unit.

Consult your physician before starting this or any exercise program. This is especially important if you are over the age of 35 or have any pre-existing health condition. If you feel faint or dizzy, immediately discontinue use of this equipment. Serious bodily injury can occur if this equipment is not assembled and used correctly. Serious bodily injury can also occur if all instructions are not followed. Keep others and pets away from equipment when in use. Follow all safety instructions in this manual.

Built-in Battery Precautions

- Do not attempt to replace the batteries yourself. For troubleshooting and assistance, you can email us at support@mycubii.com.
- Do not attempt to force open the built-in battery.
- Charge your Cubii using a certified computer, powered hub, or powered supply.

Disposal and Recycling Information



The symbol on the product or its packaging signifies that this product has to be disposed separately from ordinary household wastes at its end of life. Please kindly be aware that this is your responsibility to dispose electronic equipment at recycling centers so as to help conserve natural resources. Each country in the European Union should have its collection centers for electrical and electronic equipment recycling. For information about your recycling drop off point, please contact your local electrical and electronic equipment waste management authority or the retailer where you bought the product.

Le symbole sur le produit ou sur son emballage signifie que ce produit à la fin de sa vie doit être recyclé séparément des déchets ménagers ordinaires. Notez que ceci est votre responsabilité d'éliminer les équipements électroniques à des centres de recyclage afin d'aider à préserver les ressources naturelles. Chaque pays de l'Union européenne a ses centres de collecte et de recyclage pour le recyclage des équipements électriques et électroniques. Pour plus d'informations ou trouver un centre de recyclage, contactez votre commune ou le magasin où vous avez acheté le produit.

- Do not dispose of Cubii with household waste.
- Batteries are not to be disposed of in municipal waste stream and require separate collection.
- Disposal of the packaging and your Cubii should be done in accordance with local regulations.

For additional information on disposal and recycling, including contact details of a distributor in your region, please visit <http://mycubii.com/support>

Pour plus amples renseignements sur le recyclage, y compris les coordonnées d'un distributeur dans votre region, visitez <http://mycubii.com/support>

